

AC INPUT BALANCE
CHARGER, DISCHARGER

x1 **MINI**



HiTEC

OPERATION MANUAL

WARNING: THE CHARGING AND DISCHARGING OF RC HOBBY BATTERIES CAN BE DANGEROUS. FAILURE TO FOLLOW THE INSTRUCTIONS AND WARNINGS IN THIS MANUAL MAY RESULT IN PROPERTY DAMAGE AND/OR LOSS OF LIFE.

Table of Contents

Table of Contents:

Introduction	03
Warning and Safety Notes	04
Product Layout	08
Specifications	09
Features	10
Battery Connections	12
Input Functions	13
Program Flow Chart	14
Charger Operation	16
Memory Preset - Data Store/Load	18
Battery Meter	20
Battery Resistance Meter	21
Advanced System Set Up	22
Warning and Error Messages	24
Using Charge Master PC Software	25
Commonly Used Terms	25
Conformity Declarations	27
Disposal and Prop 65 Warning	28
Warranty and Service	28

Introduction

Congratulations on purchasing Hitec's X1 mini compact charger! Featuring a compact design, this sophisticated AC charger packs 60 watts into a fraction of the size to meet your battery management requirements. Compatible with a full range of the most popular battery types, including the new generation LiHV, the X1 mini keeps your batteries powered up with 6-amps of charging power.

Although simple to use, the X1 mini does require some background knowledge for successful and safe operation. The operating instructions included here are designed to ensure that you quickly become familiar with its functions. It is important that you read through the Operating Instructions, Warning and Safety Notes attentively and in full before attempting to use your new charger for the first time. By following the guidelines and recommendations provided, you are sure to enjoy many years of R/C fun with your new X1 mini charger!



THE CHARGING AND DISCHARGING OF RC HOBBY BATTERIES CAN BE DANGEROUS. FAILURE TO FOLLOW THESE EXPLICIT WARNINGS CAN

Warning RESULT IN PROPERTY DAMAGE AND/OR LOSS OF LIFE.

- ⚠ NEVER LEAVE YOUR CHARGER UNATTENDED WHILE IN OPERATION.
- ⚠ NEVER CHARGE ON OR AROUND COMBUSTIBLE MATERIALS.
- ⚠ NEVER CHARGE A DAMAGED BATTERY PACK.
- ⚠ LOW COST, NO-NAME BATTERY PACKS POSE THE MOST DANGER. WE RECOMMEND YOU ONLY USE BATTERY PACKS THAT ARE SOLD AND WARRANTIED BY A REPUTABLE COMPANY.
- ⚠ IT IS HIGHLY RECOMMENDED THAT YOU UTILIZE A SAFETY DEVICE SUCH AS A STEEL CASE OR LIPO SACK™ WHILE CHARGING LITHIUM CHEMISTRY BATTERIES.
- ⚠ IT IS HIGHLY RECOMMENDED THAT YOU KEEP AN OPERABLE "CLASS A" FIRE EXTINGUISHER IN THE CHARGING AREA.



FAILURE TO FOLLOW THESE WARNINGS CAN BE CONSIDERED NEGLIGENCE BY THE OPERATOR AND MAY NEGATE ANY CLAIMS

Warning FOR DAMAGES INCURRED.

Warning and Safety Notes

Hitec RCD USA will not be held responsible for any damages or injuries that may occur by persons who fail to follow these warnings or who fail to properly follow the instructions in this manual.



Warning



Tip

Warning: Be sure to read this section for your own safety.

Caution: Be sure to read this section to prevent accidents and damage to your charger.



Note



Caution

Tip: This section will help you maximize the performance of your charger.

Note: This section will provide more detailed explanations.

These warnings and safety notes are of the utmost importance. You must follow these instructions for maximum safety. Failure to do so can damage the charger and the battery and in the worst cases, may cause a fire.



NEVER LEAVE THE CHARGER UNATTENDED WHILE IT IS CONNECTED TO ITS POWER SOURCE. IF ANY MALFUNCTION IS FOUND, TERMINATE THE PROCESS AT ONCE AND REFER TO THE OPERATION MANUAL.

- ⚠ The allowable AC input voltage is 100-240V AC.
- ⚠ Keep the charger away from dust, damp, rain, heat, direct sunlight and excessive vibration.
- ⚠ If the charger is dropped or suffers any type of impact, it should be inspected by an authorized service station before using it again.
- ⚠ This charger and the battery should be put on a heat-resistant, non-flammable and non-conductive surface.
- ⚠ Never place a charger on a car seat, carpet or similar surface. Keep all flammable volatile materials away from the operating area.
- ⚠ Make sure you know the specifications of the battery to be charged or discharged to ensure it meets the requirements of this charger. If the program is set up incorrectly, the battery and charger can be damaged.
- ⚠ Fire or explosion can occur due to overcharging.

Warning and Safety Notes [cont.]

- ⚠ To avoid a short circuit between the charge lead, always connect the charge cable to the charger first, then connect the battery. Reverse the sequence when disconnecting.
- ⚠ Never attempt to charge or discharge the following types of batteries:
 - A battery fitted with an integral charge circuit or a protection circuit
 - A battery pack which consists of different types of cells (including different manufacturer's cells)
 - A battery that is already fully charged or just slightly discharged and non-rechargeable batteries (these pose an explosion hazard)
 - A faulty or damaged battery
 - Batteries installed in a device or which are electrically linked to other components
 - Batteries that are not expressly stated by the manufacturer to be suitable for the currents the charger delivers during the charge process

PLEASE BEAR IN MIND THE FOLLOWING POINTS BEFORE YOU COMMENCE CHARGING:

- Did you select the appropriate program suitable for the type of battery you are charging?
- Did you set up the adequate current for charging or discharging?
- Have you checked the battery voltage? Lithium battery packs can be wired in parallel and in series, i.e. a 2-cell pack can be 3.7V (in parallel) or 7.4V (in series).
- Have you checked that all connections are firm and secure?
- Make sure there are no intermittent contacts at any point in the circuit.

Warning and Safety Notes [cont.]

Standard Battery Parameters

	LiPo	LiPo HV	Lilon	LiFe	NiCd	NiMH	Pb
Nominal Voltage	3.7V/cell	3.7V/cell	3.6V/cell	3.3V/cell	1.2V/cell	1.2V/cell	2.0V/cell
Max. Charge Voltage	4.2V/cell	4.35V/cell	4.1V/cell	3.6V/cell	1.5V/cell	1.5V/cell	2.46V/cell
Storage Voltage	3.8V/cell	3.85V/cell	3.7V/cell	3.3V/cell	n/a	n/a	n/a
Allowable Fast Charge	≤ 1C	≤ 1C	≤ 1C	≤ 4C	≤ 1-2C	≤ 1-2C	≤ .04C
Min. Discharge Voltage	3.0-3.3V/cell	3.1-3.4V/cell	2.9-3.2V/cell	2.6-2.9V/cell	0.1-1.1V/cell	0.1-1.1V/cell	1.8V/cell



Warning

WHEN ADJUSTING YOUR X1 MINI CHARGING PARAMETERS, BE SURE YOU SELECT THE PROPER BATTERY TYPE AND CELL VOLTAGE FOR THE TYPE OF CELL YOU ARE CHARGING. CHARGING BATTERIES WITH THE WRONG SETTINGS MAY CAUSE THE CELLS TO BURST, CATCH FIRE OR EXPLODE.

Charging

Before charging your batteries, it is critical that you determine the maximum allowable charge rate for your batteries. The X1 mini is capable of charging at high rates that may not be suitable or safe for your particular batteries. For example, Lithium cells are typically safe to charge at 1C, or the total mAh ÷ 1000. A 1200mAh battery would have a 1C charge rate of 1.2 amps. A 4200mAh battery would have a 1C charge rate of 4.2 amps. Some manufacturers are offering Lithium cells that can be charged at greater than 1C but this should ALWAYS be verified before charging a Lithium battery at rates higher than 1C. Voltage is just as critical as the charging amperage rate and this is determined by the number of cells in series, or "S". For example, a 3S LiPo is rated at 11.1 volts ("S" multiplied by a single LiPo cell with a nominal voltage of 3.7 volts DC. 3 cells x 3.7 volts each equals 11.1 volts DC).

Connect the battery's main leads to the charger output: red is positive and black is negative. Keep in mind that the gauge or thickness of your charging leads from the X1 mini to your battery must be of an acceptable current rating to handle the applied charge current. For maximum safety and charging effectiveness, always match or exceed the main battery lead rating when assembling or selecting your charging leads. If you charge a battery at a high current rate (amperage) with a charging lead not rated for the chosen amperage, the wire could get hot, catch fire, short out and/or potentially destroy your battery and the charger.

Warning and Safety Notes [cont.]

When in doubt, always use a higher gauge wire (lower AWG number). It is common to see charging leads constructed of 14AWG, 16AWG or 18AWG wire.

Always refer to recommendations from your battery manufacturer for your specific battery type and size before initiating a charge or discharge process.

Do not attempt to disassemble or modify Lithium or Lead-Acid battery packs.

Discharging

The X1 mini discharging functions are for two specific purposes:

- Refreshing the capacity of a Nickel-based battery that has lost capacity over time (NiMH or NiCd).
- Reducing the voltage of a Lithium battery for safe storage.



Note

LITHIUM CHEMISTRY BATTERY PACKS SHOULD ONLY BE DISCHARGED TO THEIR MINIMUM SAFE VOLTAGE, NO LOWER. DEEP DISCHARGING A LITHIUM CELL WILL DO PERMANENT DAMAGE. REFER TO THE STANDARD BATTERY PARAMETERS TABLE ON PAGE 6 OF THIS MANUAL FOR MINIMUM DISCHARGE VOLTAGES.

LiPo & LiHV Charge/Discharge Cycling

Lithium batteries are known to reach full capacity after a break-in period of about 10 charge/discharge cycles. We do not recommend you use the X1 mini charger to do this; normal use and recharging will achieve the same results. If you wish to perform a Lithium break-in on the bench with the X1 mini, discharging to minimum acceptable voltages and performing a balance charge at 1C maximum rate is recommended. If you choose to break in your Lithium batteries under normal use, charging at only 1C for the first ten cycles will help ensure full performance and service life from your Lithium cells.

Product Layout

In the case of an error, the screen will communicate the cause of the error and emit an audible sound.

The Set Contains:

- 1 x X1 mini Charger
- 1 x Power Cord
- 1 x 2 Pin T-Type Battery Charge Cable
- 1 x XT60 Battery Charge Cable



Specifications

X1 mini Specifications	
AC Input	100 - 240 Volts AC
Total Charge Circuit Power	60 Watts AC input
Charge Current Range	0.1 - 6.0 Amps
Discharge Current Range	0.1 - 2.0 Amps
Discharge Current Power	10 Watts
Current Drain for LiPo Balancing	Max 200mA per cell
NiCd/NiMH Battery Cell Count	6 - 8 Cells
- Capacity Range	100 - 50000mAh
LiPo/LiHV/LiFe/Lilon Cell Count	2 - 4 Cells
- Capacity Range	100 - 50000mAh
Pb Battery Voltage	6 - 12 Volts
- Capacity Range	100 - 50000mAh
Net Weight	0.68 lbs
	310g
Dimensions	4.41 x 4.17 x 2.05in
	112 x 106 x 52mm

Features

Optimized Operating Software:

The X1 mini features the user-friendly AUTO function that sets the feeding current during the process of charging or discharging. For lithium batteries especially, it can prevent overcharging and any resulting consequences. With the AUTO function, users can disconnect the circuit automatically and trigger a single alarm to sound if any malfunction has been detected. All programs unique to the X1 mini are controllable through a two-way linkage and communication system intended to maximize safety and minimize the trouble. Every setting is customizable according to user preference.

Battery Memory (Data Store/Load):

The X1 mini is capable of storing up to 10 different charge/discharge profiles for your convenience. Users can keep the data pertaining to any program setting for any battery to facilitate seamless charging or discharging. Saved profiles can be accessed and recalled as necessary.

Terminal Voltage Control(TVC):

For experienced users, the charger's end voltage can be reset.

“Charge Master” PC Control Software:

Compatible with the with downloadable “Charge Master” software, the X1 mini gives you unparalleled ability to operate the charger via your personal computer. You can monitor pack voltage, cell voltage, and other data during battery charging or view the charge data in real-time graphs. The “Charge Master” gives you the option to initiate and update firmware as well.

Internal Independent Lithium Battery Balancer:

The X1 mini employs an individual-cell-voltage balancer. It is not necessary to connect an external balancer for balance charging.

Individual Cell Balancing While Discharging:

During the discharge process, the X1 mini can monitor and balance each cell of the battery individually. If the voltage of any single cell reads abnormally, an error message will display and end the process automatically.

Adaptable to Various Types of Lithium Battery:

The X1 mini is adaptable to various types of lithium batteries, including LiPo, Lilon, LiFe and the new LiHV batteries.

Features [cont.]

Fast and Storage Mode of Lithium Battery:

Depending on your application requirements, you may choose fast charge or storage mode. Fast charge reduces the amount of time required for charging, whereas 'store' state controls the final voltage of your battery.

Re-Peak Mode of NiMH/NiCd Battery:

In re-peak charge mode, the charger can peak charge the battery once, twice, or three times in a row automatically. This function is useful for ensuring a full battery charge.

Delta-Peak Sensitivity for NiMH/NiCd:

This automatic charge termination program is based on the principle of the Delta-peak voltage detection. When the battery's voltage exceeds the threshold, the process will be terminated automatically.

Cyclic Charging/Discharging:

1 to 5 cyclic and continuous charge > discharge or discharge > charge sessions are optimal for battery performance and balancing.

Automatic Charging Current Limit:

You can set the upper limit of the charging current when charging your NiMH or NiCd battery. The 'AUTO' charging mode, however, is recommended when charging NiMH batteries with low impedance and capacity.

Battery Meter:

The user can check the battery's total voltage, the highest voltage, the lowest voltage and the voltage of each cell. The user can also check the battery's total internal resistance and the internal resistance of each cell.

Capacity Limit:

The charging capacity is always calculated as the charging current multiplied by time. If the charging capacity exceeds the limit, the process will automatically terminate according to the maximum value previously set.

Temperature Threshold*:

The battery's internal chemical reaction will cause the temperature of the battery to rise. If the temperature limit is reached, the process will be terminated.

* This function is available by connecting an optional temperature probe which is available as a separate purchase.

Processing Time Limit:

Protect your battery by setting a maximum time limit for charging and discharging.

Battery & Power Supply Connections

1.) Connecting to Power Source:

It is an AC charger only. Please insert the AC power cord to the wall socket (100-240V) directly to power it on.

2.) Connecting the Battery:

Important!!! Before connecting a battery, it is absolutely essential to check one last time that you have set the parameters correctly. If the settings are incorrect, the battery may be damaged and could even burst into flames or explode. To avoid short circuits between the banana plugs, always connect the charge leads to the charger first and only then to the battery. Reverse the sequence when disconnecting the pack.

3.) Balance Socket:

In default setting, for safety issue, it requests to use balance charging wire with balance board to charge Lithium batteries in all modes. If the charging battery has no balance wire, please disable this function in system setting program as following:



Warning

TO AVOID SHORT CIRCUITS, ALWAYS CONNECT THE CHARGE LEADS TO THE CHARGER FIRST, AND THEN TO THE BATTERY. REVERSE THE SEQUENCE WHEN DISCONNECTING THE PACK.

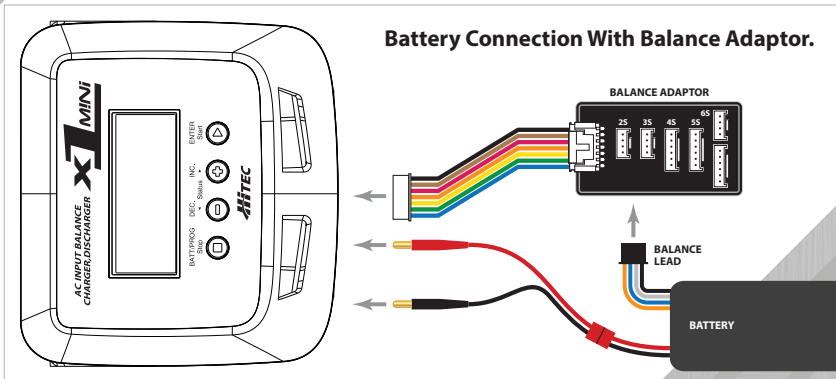

Input Functions



Scroll Through the Main Menu ,Stop Any Charge Processes

Resume or Start Charge Processes, Confirm Any Action
Alter Values
See the Status of Individual Cells in Balance Charge Mode

BATT PROG / STOP Button:

Stop a function in-progress or to go back to previous step/screen.

DEC Button:

Scroll through menus or decrease the parameter value.

INC Button:

Scroll through the menus or increase the parameter value.

ENTER / START Button:

Enter parameters or store parameters on-screen. Start the charge/discharge process.

When changing a parameter value in the program, press the START/ENTER button to make it blink, then change the value by pressing the DEC and INC button. The value will be stored by repressing the START/ENTER button. If there is a second parameter to edit on the same screen, it will begin blinking after you confirm the first parameter value.

When you first power the charger on it displays the last processes used. From here you can change the battery type or press enter to change the charge/discharge process, charge/discharge current rate and/or battery cell count. If you are charging a battery identical to the last one used and want to perform the same process then simply press the start to begin that process.

Program Flow Chart

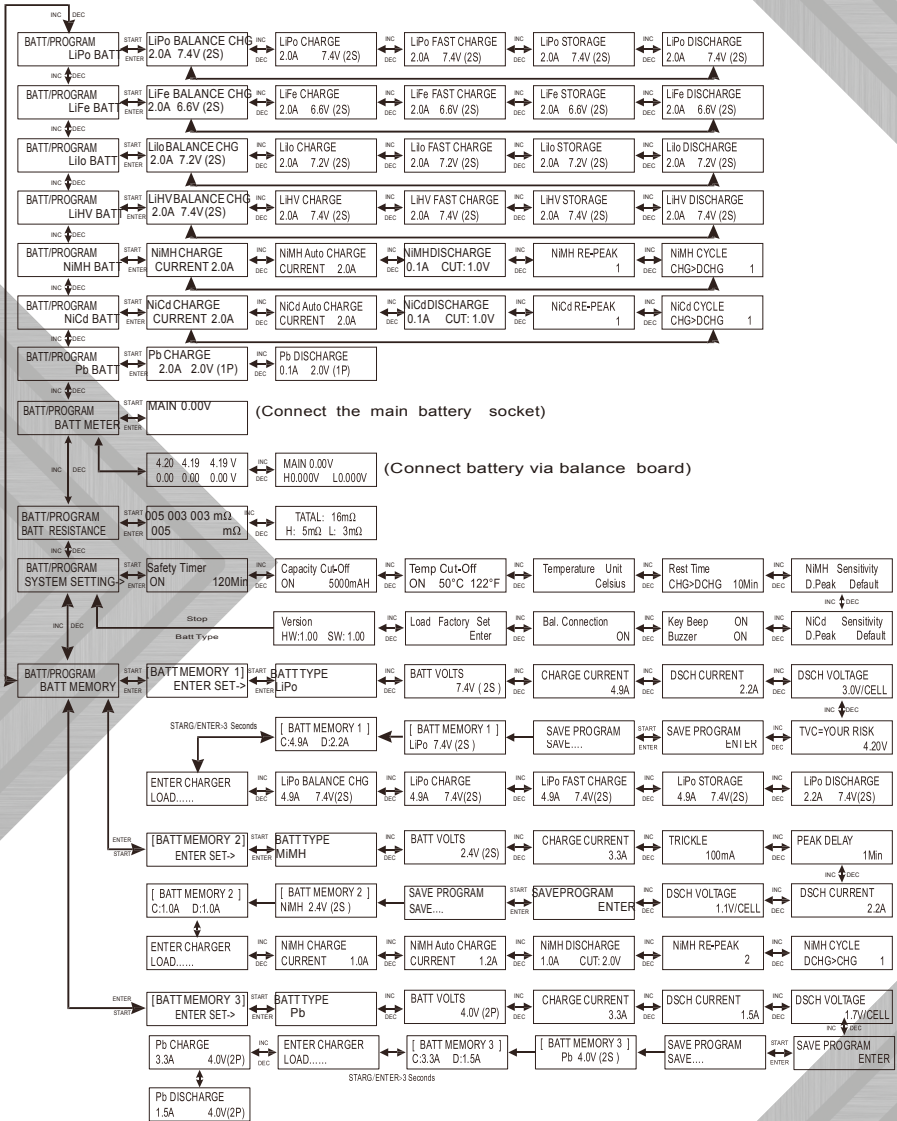

For larger version visit www.hitecrd.com

Charger Operation

It is highly recommended to have the flowchart handy while learning to operate this charger. There are two main ways to setup the charger:

(1) Memory profile are available for setting and storing charge or discharge parameters for up to 10 different batteries. Once a battery's information is stored into memory, it will be retained until changed again manually. Recalling a battery's memory number makes the charger instantly ready to go!

(2) The other method is by manually setting up the charge or discharge process each time. The X1 mini is capable of the following processes:

Batt Type	Operation Program	Description
LiPo Lilon LiFe LiHV	CHARGE	This charging mode is for charging LiPo/LiFe/Lilon/LiHV battery in normal mode.
	DISCHARGE	This mode is for discharging LiPo/LiFe/Lilon/LiHV battery.
	STORAGE	This program is for charging or discharging lithium battery which will not be used for long time.
	FAST CHG	The charging capacity may be less than normal charging but the process time will be reduced.
	BAL CHARGE	This mode is for balancing the voltage of lithium-polymer battery cells while charging
NiMH NiCd	CHARGE	The charger will charge NiMH and NiCd batteries using the charge current set by the user.
	AUTO CHG	In this program the charger detects the condition of the battery which is connected to the output and automatically charges the battery. <i>Note: You should set up the upper limit of the charge current to avoid damage by excessive feeding current. Some batteries of low resistance and capacity can lead to higher current.</i>
	DISCHARGE	This mode is for discharging NiMH/NiCd battery.
	RE-PEAK	In re-peak charge mode, the charger can peak charge the battery once, twice or three times in a row automatically. This is good for confirming the battery is fully charged, and for checking how well the battery receives fast charges.
	CYCLE	1 to 5 cyclic and continuous process of charge>discharge or discharge>charge is operable for battery refreshing and balancing to stimulate the battery's activity.
Pb	CHARGE	This mode is for charging Pb battery.
	DISCHARGE	This mode is for discharging Pb battery.

Charger Operation [cont.]

The following steps describe how to manually setup the X1 mini:

BATT/PROGRAM
LiPo BATT

START/ENTER

LiPo BALANCE CHG
2.0A 11.1V (3S)

START/ENTER

LiPo BALANCE CHG
2.0A 11.1V (3S)

START/ENTER

LiPo BALANCE CHG
2.0A 11.1V (3S)

START/ENTER

LiPo BALANCE CHG
2.0A 11.1V (3S)

START/ENTER
> 3 Seconds

BATTERY CHECK
WAIT...

R: 3SER S: 3SER
CANCEL (STOP)

3. BATT/PROGRAM Select: Press INC and DEC to scroll through all programs and press START/ENTER to enter the LiPo BATT Program.

4. Mode Select: Press INC and DEC to scroll through all modes and press START/ENTER to enter LiPo Balance Charge Mode.

5. Battery Setting: Press START/ENTER. The current value will start to blink, Press INC and DEC to change the value and press START/ENTER to confirm your setting.

At the same time, the battery cell's number will start to blink. Press INC and DEC to change the value and press START/ENTER to confirm your setting.

6. Program Start: Press and hold START/ENTER for 3 seconds to start the program.

The charger is detecting the number of cells.

R shows the number of cells detected by the charger and S is the number of cells set by the user at the previous screen. If the numbers are not identical, press STOP to go back to the previous screen and recheck the number of cells in the battery pack before proceeding.

Charger Operation [cont.]

```
R:3SER S:3SER  
CONFIRM(ENTER)
```

START/ENTER

```
LP4s 1.5A 12.14V  
BAL 000:50 00022
```

If both numbers are identical, press START/ENTER to begin the charging process.

7. Charging Status Monitor: During the charge process, the real-time status will be visible on the left side of the screen.

Information Displayed While Operating

Pressing INC or DEC during the charging or discharging process allows the user to view a variety of information on the LCD screen.

```
LP4s 1.5A 12.14V  
BAL 000:50 00022
```

INC ▶

```
4.07 4.06 4.11 V  
0.00 0.00 0.00 V
```

▶ INC

```
Fue1= 90% C  
e11= 4.10V
```

Real-time status: battery type, battery cell, charge current, battery voltage, elapsed time and charged capacity.

Voltage of each cell in the battery pack when the battery is connected with balance lead.

Charged capacity percentage and average cell voltage of the battery pack.

```
LP4s 1.5A 12.14V  
BAL 000:50 00022
```

◀ DEC

```
End Voltage  
12.6UC3SD
```

◀ DEC

```
Ext. Temp ----  
Int. Temp 37 C *
```

◀ DEC

```
Temp Cut-off  
50°C
```

◀ DEC

```
Safety Time  
ON 00:00:00
```

◀ DEC

```
Capacity Cut-Off  
ON 5000mAh
```

Final voltage when the program ends.

Internal and External temperature.

(Temperature probe required to show external temperature.)

Cut off temperature.

Safety timer ON and duration of time in minutes.

Capacity cut-off ON and the setting value of capacity.

8. Program Stop: During the charging process, press STOP to stop the charging process.

9. Program Complete: When the charging process finishes, an audible sound will play.

Memory Preset - Data Save/Load

Memory Preset - Data Save/Load:

The Save Data and Load Data programs make it easy to store and load charge and discharge profiles for up to 10 batteries per channel. Data can be saved for each battery type and each charge mode available with the X1 mini. This allows you to recall data for each battery when charging or discharging without having to set up the program over again. You can also edit settings for each saved battery.

Save Data:

**BATT MEMORY 11
ENTER SET ->** From the BATT/PROGRAM menu use the + or — buttons to scroll to the BATT MEMORY program and press the ENTER/Start ► button to enter the battery memory program. In the corner of the screen you will see the number 1 flashing, use the + or — buttons to scroll to scroll through the memories. When you are ready to select a memory to program, press the ► button again to enter the memory setup menu.

**BATT TYPE
LiPo** Press the ► button again and the battery type will begin to flash. Use the + or — buttons to select the battery type (LiPo, LiFe, Lilon, LiHV, NiMH, NiCd or Pb, then press the ► button to confirm your selection.

Now you will use + or — buttons to scroll through the battery parameters, using the + you will make adjustments in the following order, using the — button will reverse this order.

**BATT VOLTS
7.4V (2S)** **Voltage and Number of Cells:** Press the ► button and the number of cells will begin to flash. Use the + or — buttons to change the cell count then press the ► button to confirm your selection.

**CHARGE CURRENT
4.9A** **Charge Current:** Press the ► button and the charge current value will begin to flash. Use the + or — buttons to change the charge current then press the ► button to confirm your selection.

**DSCH CURRENT
2.0A** **Discharge Current:** Press the ► button and the discharge current value will begin to flash. Use the + or — buttons to change the discharge current then press the ► button to confirm your selection.

Memory Preset - Data Save/Load [cont.]

DSCH VOLTAGE
3.0V/CELL

Per Cell Discharge Voltage: Press the ► button and the per cell discharge voltage value will begin to flash. Use the + or — buttons to change the per cell discharge voltage, then press the ► button to confirm your selection.



MAKE SURE TO FOLLOW YOUR BATTERY MANUFACTURERS RECOMMENDATIONS REGARDING DISCHARGING. FAILURE TO DO SO

Warning MAY DESTROY THE BATTERY OR RENDER IT UNSAFE FOR USE.

TUC = YOU R RISK
4.20V

Terminal Voltage: Press the ► button and the terminal voltage value will begin to flash. Use the + or — buttons to change the terminal voltage, and then press the ► button to confirm your selection.



CHANGING THE TERMINAL VOLTAGE IS ONLY INTENDED FOR EXPERT USERS, ANY CHANGES TO DEFAULT SETTINGS ARE COMPLETELY AT YOUR

Warning OWN RISK.

SAVE PROGRAM
ENTER

Save Program: Press the ► button to save the program.

SAVE PROGRAM
SAVE...

SAVE..... will appear momentarily while the program is written to the memory.

[BATT MEMORY 1]
LiPo 7.4V (2S)

Once saved the screen indicate the memory number, battery type, cell count, charge current and discharge current.

[BATT MEMORY 1]
C: 4.9 D: 2.2A

Recall Memory:

ENTER CHARGER
LOAD...

From the BATT/PROGRAM menu use the + or — buttons to scroll to the BATT MEMORY program and press ► button to enter the battery memory program . Use the + or — buttons to scroll to scroll through the memories. When you have found the memory you would like to use press and the ► button again to recall the memory.

LiPo BALANCE CHG
4.9A 7.4V (2S)

Use the + or — buttons to scroll the available proceses (charge, discharge, balance charge etc.). Select the process you would like to execute for the battery then press and hold the ► button for 3 seconds to begin the selected process.

Battery Meter

Battery Meter:

The user can check the battery's total voltage, the highest voltage, the lowest voltage and each cell's voltage in the battery pack.

Connect the battery to the charger by inserting the main battery lead to the battery socket and balance wires to balance socket.



This diagram shows the correct way to connect your battery to check the voltage.

BATT/PROGRAM
BATT METER

Press the START/ENTER button to access the Lithium Battery Meter program.

4.20 4.19 4.19V
4.18 4.18 4.19V

Indicates each cell's voltage.

MAIN 25.13V
HH.200 V LL.182V

Indicates the total voltage, the highest voltage and the lowest voltage.

Battery Resistance Measurement

Battery Resistance Measurement:

The user can check the battery's total resistance, the highest resistance, the lowest resistance and each cell's resistance in the battery pack.

Connect the battery to the charger by inserting the main battery lead to the battery socket and balance wires to balance socket.



BATT/PROGRAM
BATT RESISTANCE

Press the START/ENTER button to access the Lithium Battery Resistance program.

012 005 005 mΩ
006 mΩ

The first screen indicates each cell's internal resistance.



TOTAL: mΩ
H: 12mΩ L: 5mΩ

Indicates the total resistance, the highest resistance and the lowest resistance.

Advanced System Set Up

The system will be set to its default parameters when powered on for the first time. The screen displays the following information in sequence and the user can change any given value on each screen.

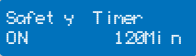
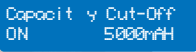
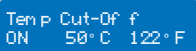
To change a parameter value in the program, press START/ENTER to make that value blink. Next, change the value by pressing INC or DEC. The value will be stored by pressing START/ENTER once.

ITEM	SELECTION	DESCRIPTION
	OFF/ ON (1-720 Min)	When you start a charge process, the integral safety timer automatically starts running at the same time. This is programmed to prevent overcharge the battery if it proves to be faulty, or if the termination circuit cannot detect the battery full. The value for the safety timer should be generous enough to allow a full charge of the battery.
	OFF/ ON (100-50000 mAh)	This program sets the maximum charge capacity that will be supplied to the battery during charge. If the delta peak voltage is not detected nor the safety timer expired by any reason, this feature will automatically stop the process at the selected capacity value.
	OFF/ ON (20°C/68°F - 80°C/176°F)	The battery's internal chemical reaction will cause the temperature of the battery to rise. If the temperature limit is reached, the process will be terminated.
	Celsius Fahrenheit	You can choose the temperature displayed by Celsius or Fahrenheit as you like.
	1-60Min	A rest time allowing the battery to cool down between charging/discharging cycle.

Advanced System Set Up [cont.]

ITEM	SELECTION	DESCRIPTION
NiMH Sensitivity D.Peak D efault	Default: 4 mV/Cell 3-15mV/Cell	This program is for NiMH/NiCd batteries only. When the charger detects that the delta peak value has reached the value set by the user, the battery will read fully charged.
NiCd Sensitivity D.Peak D efault		
<div style="border: 1px solid black; padding: 2px; display: inline-block;"> Key Beep ON Buzzer ON </div>	OFF/ON	A beep sounds with the press of each button to confirm your action. The beep or melody sounded at various times during operation to alert different mode changes.
<div style="border: 1px solid black; padding: 2px; display: inline-block;"> Bal. Connection ON </div>	OFF/ON	For increased safety when charging Lithium batteries, connect the balance wire of the battery to balance sockets in any mode, whether Fast Charge or Storage Mode. This function may be disabled.
<div style="border: 1px solid black; padding: 2px; display: inline-block;"> Load Factory Set Enter </div>		Press ENTER to load the factory default settings.
<div style="border: 1px solid black; padding: 2px; display: inline-block;"> Version HW:1.00 FW: 1.10 </div>		Indicates the hardware and firmware version.

Warning and Error Messages

In the case of an error, the screen will communicate the cause of the error and emit an audible sound.

REVERSE POLARITY

Reversed polarity is detected.

CONNECTION BREAK

The battery connection has been broken.

CONNECT ERROR
CHECK MAIN PORT

The battery connection is incorrect.

BALANCE CONNECT
ERROR

The balance connection is incorrect.

CELL ERROR
LOW VOLTAGE

The Voltage of one cell in the battery pack is too low.

CELL ERROR
HIGH VOLTAGE

The voltage of one cell in the battery pack is too high.

CELL ERROR
VOLTAGE-INVALID

The voltage of one cell in the battery pack is invalid.

CELL NUMBER
INCORRECT

The number of cells number is wrong.

INT. TEMP. TOO HI

The internal temperature of the unit is too high.

EXT. TEMP. TOO HI

The external temperature of the battery is too high.

OVER CHARGE
CAPACITY LIMIT

The battery capacity is more than the maximum capacity set by the user.

OVER TIME LIMIT

The charging time is longer than the maximum charging time set by the user.

BATTERY HAS FULL

The battery voltage is higher than the maximum voltage set by the user when charging in balance mode.

CONTROL FAIL

Battery pack voltage is lower than 5 volts. The X1 Mini cannot charge a pack with a voltage of less than 5v.

Using the Charge Master PC Software

The free "Charge Master" software gives you unparalleled ability to operate the charger through your PC computer. You can monitor pack voltage, cell voltage, and other data during charging, view the charge data in real-time graphs, or control charging and firmware updates from the "Charge Master."

In order to connect the charger to a computer and enjoy the benefits of the "Charge Master" program, you will need a USB cable which is not included in this package. The cable must have an "A" plug on one end and a "micro-B" plug on the other to connect to the charger directly.

The "Charge Master" is available for download at www.hitecrd.com.

Commonly Used Terms

Commonly Used Terms:

A, mA: Unit of measurement relating to a charge or discharge current. 1000 mA = 1A (A = Ampere, mA = Milliampere).

Ah, mAh: Unit of measurement for the capacity of a battery (Amperes x Time Unit; h = hour). If a pack is charged for one hour at a current of 2A, it has been fed 2Ah of energy. It receives the same quantity of charge (2Ah) if it is charged for 4 hours at 0.5A, or 15 minutes (=1/4 hour) at 8A.

'C' - Rating: Capacity is also referred to as the 'C' rating. Some battery suppliers recommend charge and discharge currents based on the battery 'C' rating. A battery's '1C' current is the same number as the battery's rated capacity number, but noted in mA or amps. A 600mAh battery has a 1C current value of 600mA, and a 3C current value of (3 x 600mA) 1800mA or 1.8A. The 1C current value for a 3200mAh battery would be 3200mA (3.2A).

Final Charge Voltage: The voltage at which the battery's charge limit (capacity limit) is reached after which the charge process switches from a high current to a low maintenance rate (trickle charge). From this point on, any further high current charging would cause overheating and eventual terminal damage to the pack.

Commonly Used Terms [cont.]

Final Charge Voltage: The voltage at which the battery's charge limit (capacity limit) is reached after which the charge process switches from a high current to a low maintenance rate (trickle charge). From this point on, any further high current charging would cause overheating and eventual terminal damage to the pack.

Final Discharge Voltage: The voltage at which the battery's discharge limit is reached. The chemical composition of the batteries determines the level of this voltage. Below this voltage, the battery enters deep discharge zone. Individual cells within the pack may become reverse polarized under these conditions, resulting in permanent damage.

Nominal Voltage (V): The nominal voltage of the battery pack can be determined as follows:

- **NiCd or NiMH:** Multiply the total number of cells in the pack by 1.2. An 8-cell pack will have a nominal voltage of 9.6 volts (8×1.2).
- **LiPo:** Multiply the total number of cells in the pack by 3.7. A 3-cell LiPo wired in series will have a nominal voltage of 11.1 volts (3×3.7).
4-cell LiHV wired in a series will have a nominal voltage of 14.8 volts. (4×3.7).
- **Lilo:** Multiply the total number of cells in the pack by 3.6. A 2-cell Lilo wired in a series will have a nominal voltage of 7.2 volts (2×3.6).
- **LiFe:** Multiply the total number of cells in the pack by 3.3. A 4-cell LiFe wired in a series will have a nominal voltage of 13.2 volts. (4×3.3).
- **LiHV:** Multiply the total number of cells in the pack by 3.7. A 4-cell LiHV wired in a series will have a nominal voltage of 14.8 volts. (4×3.7).



Note

If the nominal voltage of the battery is not printed on the battery's label, consult your battery manufacturer or supplier. Do not attempt to guess the rated voltage of the battery.

Conformity Declarations

Hitec's X1 mini satisfies all relevant and mandatory CE directives and complies with FCC Part 15 Subpart B: 2010.

For EC directives: The product has been tested to meet the following technical standards:

Test Standards	Title	Result
EN 55014-1:2006+ A1:2009+A2:2011	EN 55014-1: Electromagnetic Compatibility - Requirements for household appliances, electric tools and similar apparatus -a Part 1: Emission	Conform
EN 55014-2:1997+ A1:2001+A2:2008	EN 55014-2: Electromagnetic Compatibility - Requirements for household appliances, electric tools and similar apparatus - Part 2: Immunity product family standard	Conform
EN 61000-3-2:2006+ A1:2009+A2:2009	EN 61000-3-2: Electromagnetic Compatibility (EMS) Part 3-2: Limits for harmonic current emissions(Equipment input current up to and including 16A per phase)	Conform
EN 61000-3-3:2008	EN 61000-3-3: Electromagnetic Compatibility (EMS) Part 3-3: Limitation of voltage supply systems for equipment with rated current $\leq 16A$	Conform
EN 60335-1:2012	Part 1: General requirements	Conform
EN 60335-2-29:2004 +A2:2010	Part 2-29: Particular requirements for battery chargers Measurement methods for electromagnetic fields of household appliances and similar apparatus with regard to human exposure	Conform

Disposal and Prop 65 Warning



This symbol indicates that when this type of electronic device reaches the end of its service life, it cannot be disposed of with normal household waste and must be recycled. To find a recycling center near you, refer to the internet or your local phone directory for electronic waste recycling centers.

STATE OF CALIFORNIA PROPOSITION 65 WARNING:

This product contains chemicals known to the State of California to cause cancer. Use caution when handling this product and avoid exposure to any electronic components or internal assemblies.

Warranty and Service

LIABILITY EXCLUSION:

This charger is designed and approved exclusively for use with the types of batteries stated in this Instruction Manual. Hitec RCD, USA accepts no liability of any kind if the charger is used for any purpose other than that stated. We are unable to ensure that you follow the instructions supplied with the charger, and we have no control over the methods you employ for using, operating and maintaining the device. For this reason we are obliged to deny all liability for loss, damage or costs which are incurred due to any misuse or operation of our products. Unless otherwise prescribed by law, our obligation to pay compensation, regardless of the legal argument employed, is limited to the invoice value of Hitec RCD, USA products which were immediately and directly involved in the event in which the damage occurred.

ONE YEAR LIMITED WARRANTY:

For a period of one year from the date of purchase HITEC RCD USA, INC. shall REPAIR OR REPLACE, at our option, defective equipment covered by this warranty, otherwise the purchaser and/or consumer is responsible for any charges for the repair or replacement of the charger. This warranty does not cover cosmetic damages and damages due to acts of God, accident, misuse, abuse, negligence, improper installation, or damages caused by alterations by unauthorized persons or entities. This warranty only applies to the original purchaser of this product and for products purchased and used in the United States of America, Canada and Mexico. Plastic cases are not covered by this warranty.

Warranty and Service [cont.]

THIS WARRANTY IS IN LIEU OF ANY AND ALL OTHER WARRANTIES, WHETHER FOR MERCHANTABILITY OR FITNESS FOR A PARTICULAR PURPOSE AND WHETHER EXPRESS OR IMPLIED. REPAIR OR REPLACEMENT AS PROVIDED UNDER THIS WARRANTY IS THE EXCLUSIVE REMEDY. HITEC RCD, INC. SHALL NOT BE LIABLE FOR ANY INCIDENTAL OR CONSEQUENTIAL DAMAGES FOR BREACH OF ANY EXPRESS OR IMPLIED WARRANTY RELATING TO THIS PRODUCT. EXCEPT TO THE EXTENT PROHIBITED BY APPLICABLE LAW. ANY IMPLIED WARRANTY OF MERCHANTABILITY OR FITNESS FOR A PARTICULAR PURPOSE ON THIS PRODUCT IS LIMITED IN DURATION TO THE DURATION OF THIS WARRANTY. REPAIR AND SERVICE.

To have your Hitec charger serviced:

1. Visit the Hitec website at www.hitecrcd.com and download the service request form (under Support section).
2. Fill out the service request form completely and include a copy of your original receipt showing the purchase date.
3. Package your product in its original packaging or use a suspension-type packaging (foam peanuts or crumpled newspaper). Hitec RCD shall not be responsible for goods damaged in transit.
4. Ship prepaid (COD or postage-due returns will not be accepted) via a traceable common courier (UPS, insured parcel post, FedEx, etc.) to:

Hitec RCD USA, Inc., Customer Service Center, 12115 Paine St., Poway CA 92064



W: www.hitecrd.com | E: service@hitecrd.com | P: 858.748.6948